

STRENGTH THROUGH (STRUCTURAL) GEOMETRY

Prof. Dr. Philippe Block

ETH Zürich | Institute of Technology in Architecture | Block Research Group

National Centre of Competence in Research (NCCR) Digital Fabrication

ETH zürich **BRG**



1

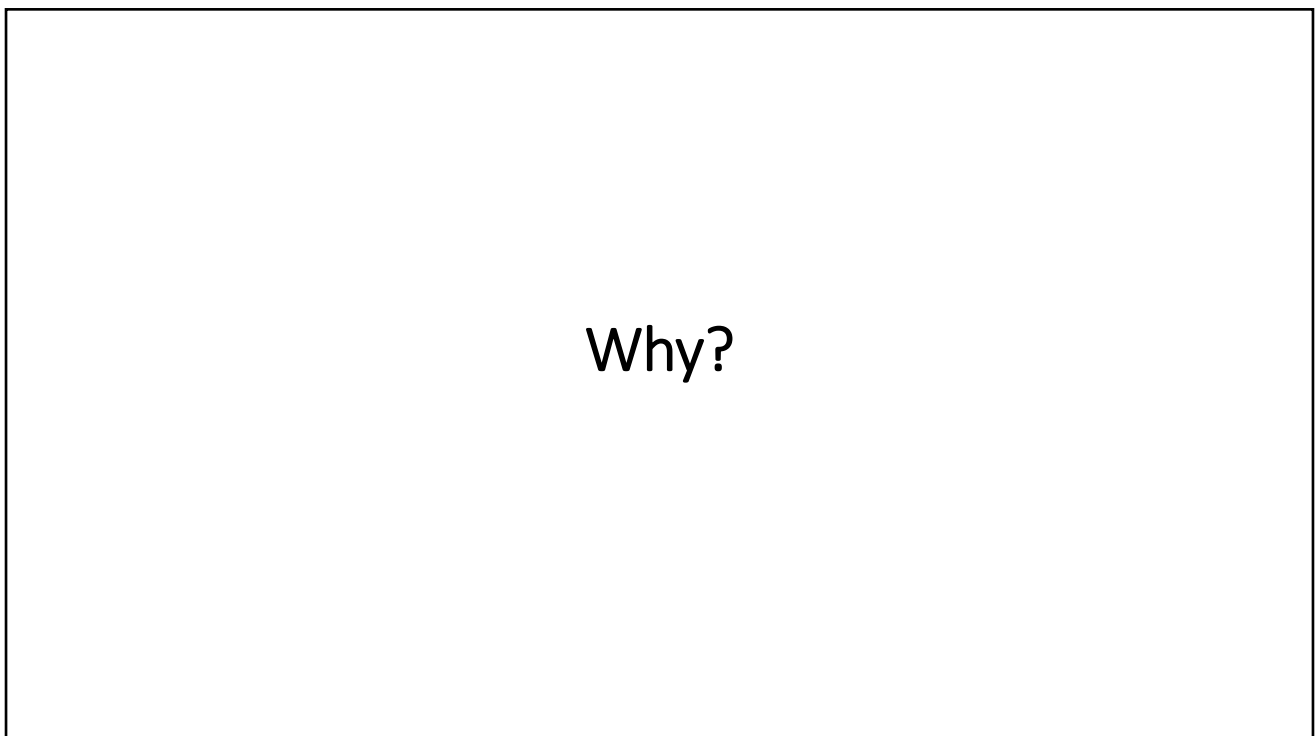

Why?

2

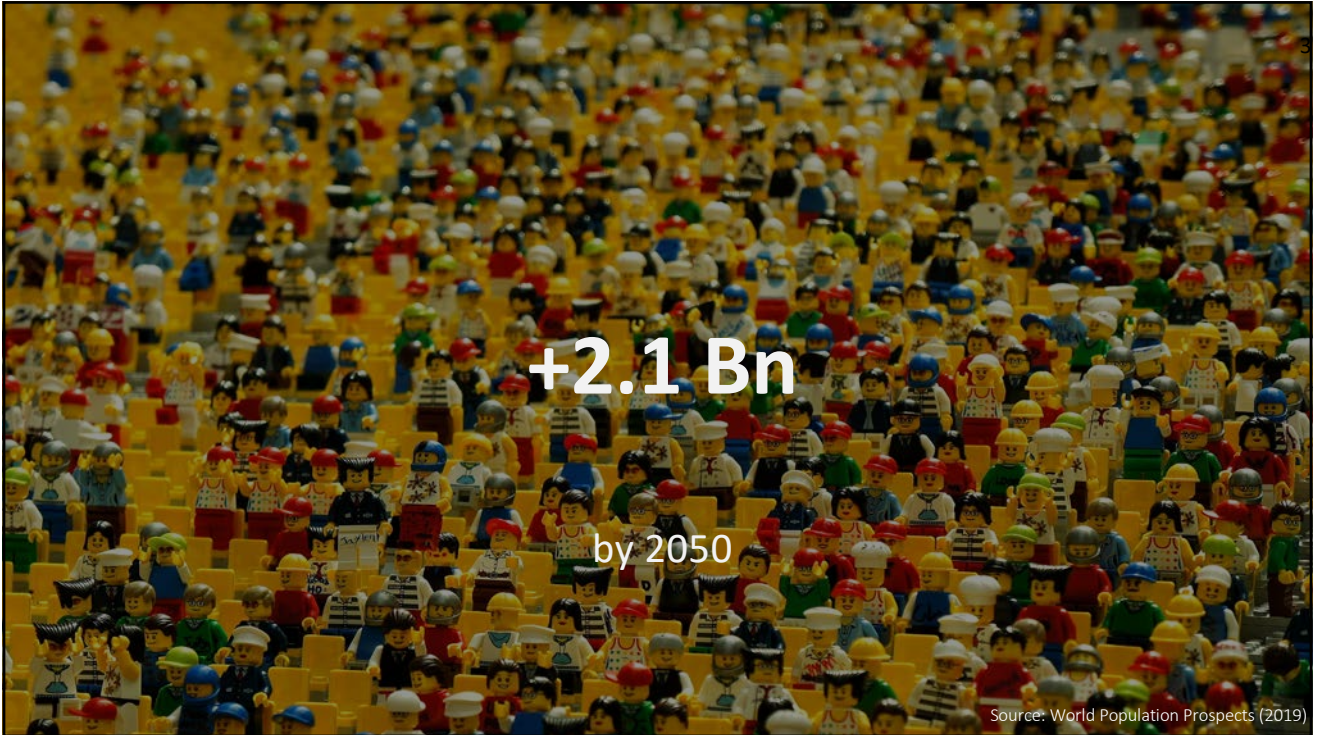

3

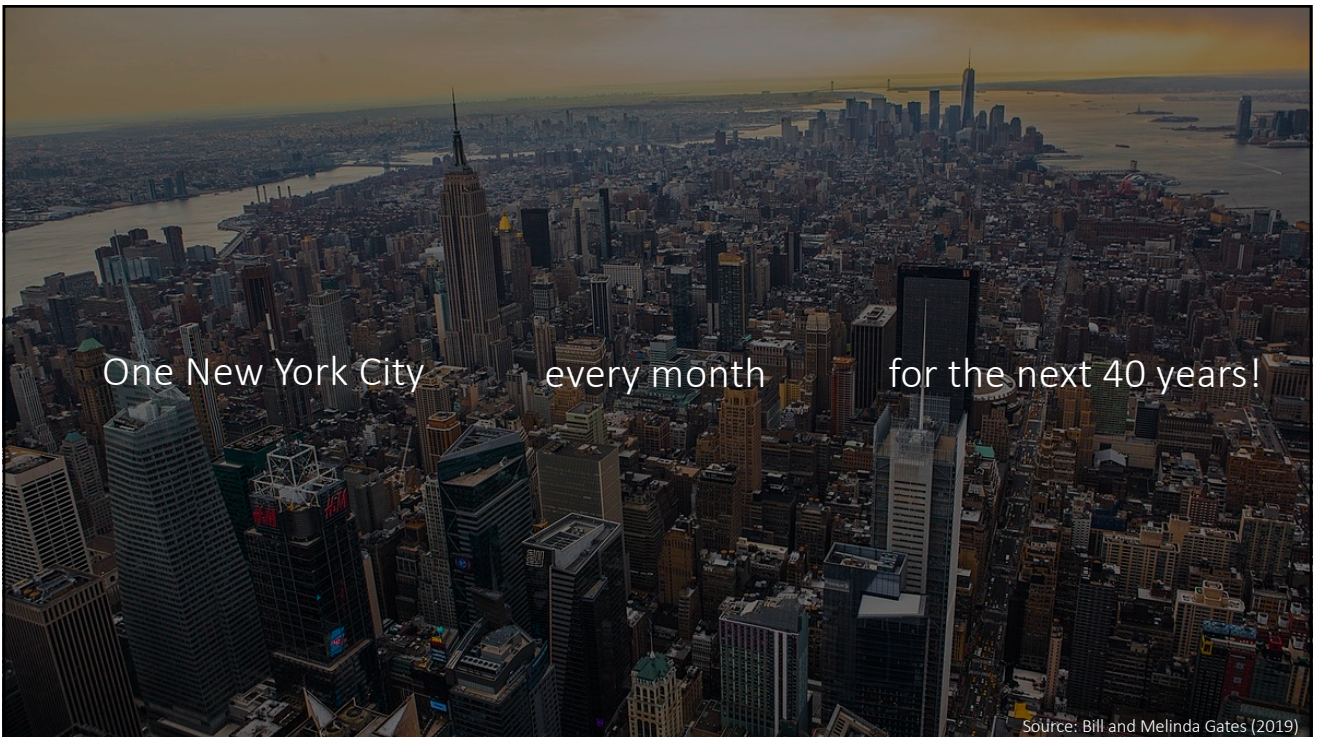

4

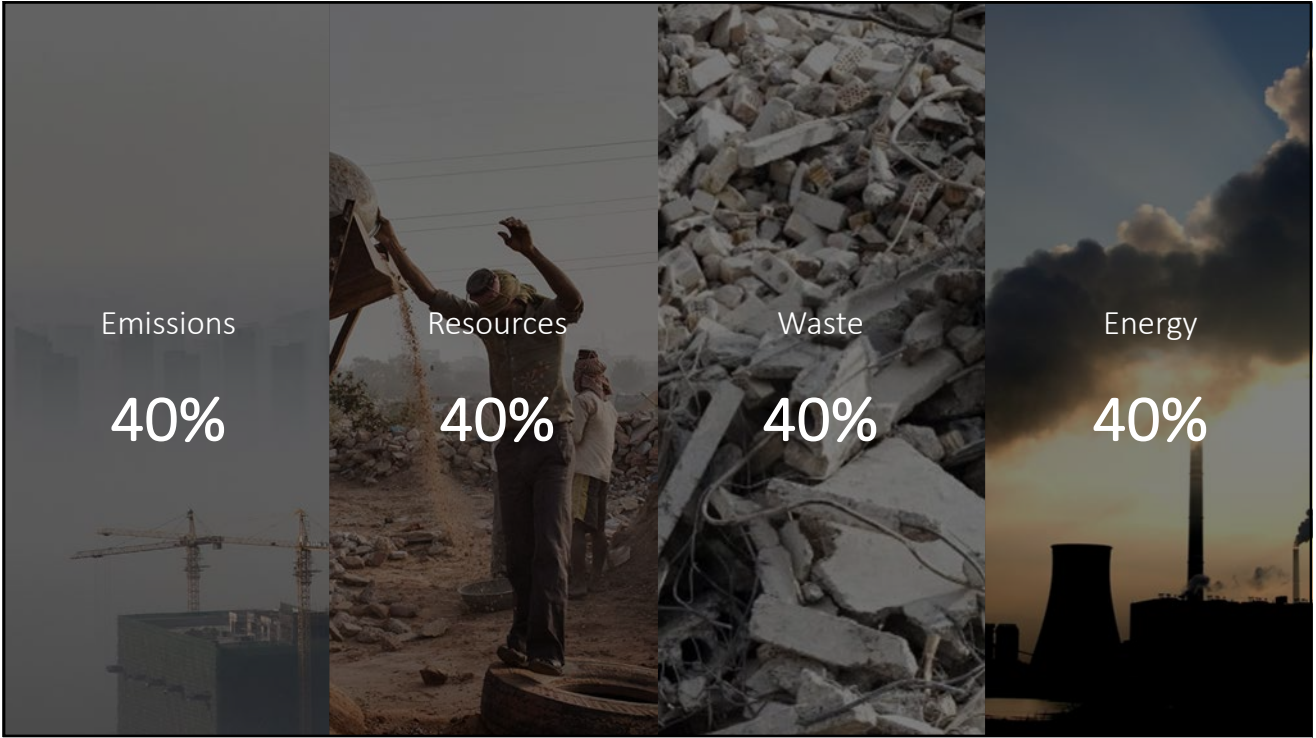

5

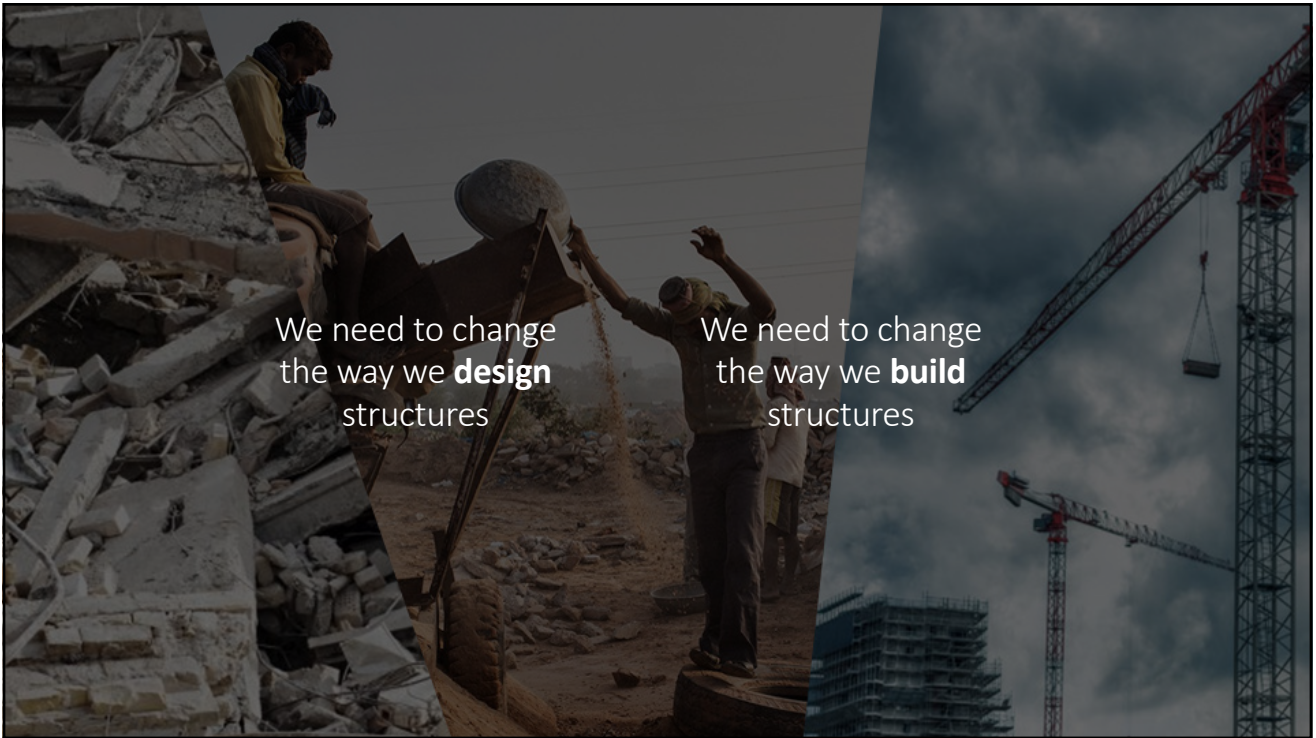

6

Mapungubwe

Limpopo, South Africa, 2008

7



8



9



10



11



12



13



14



15

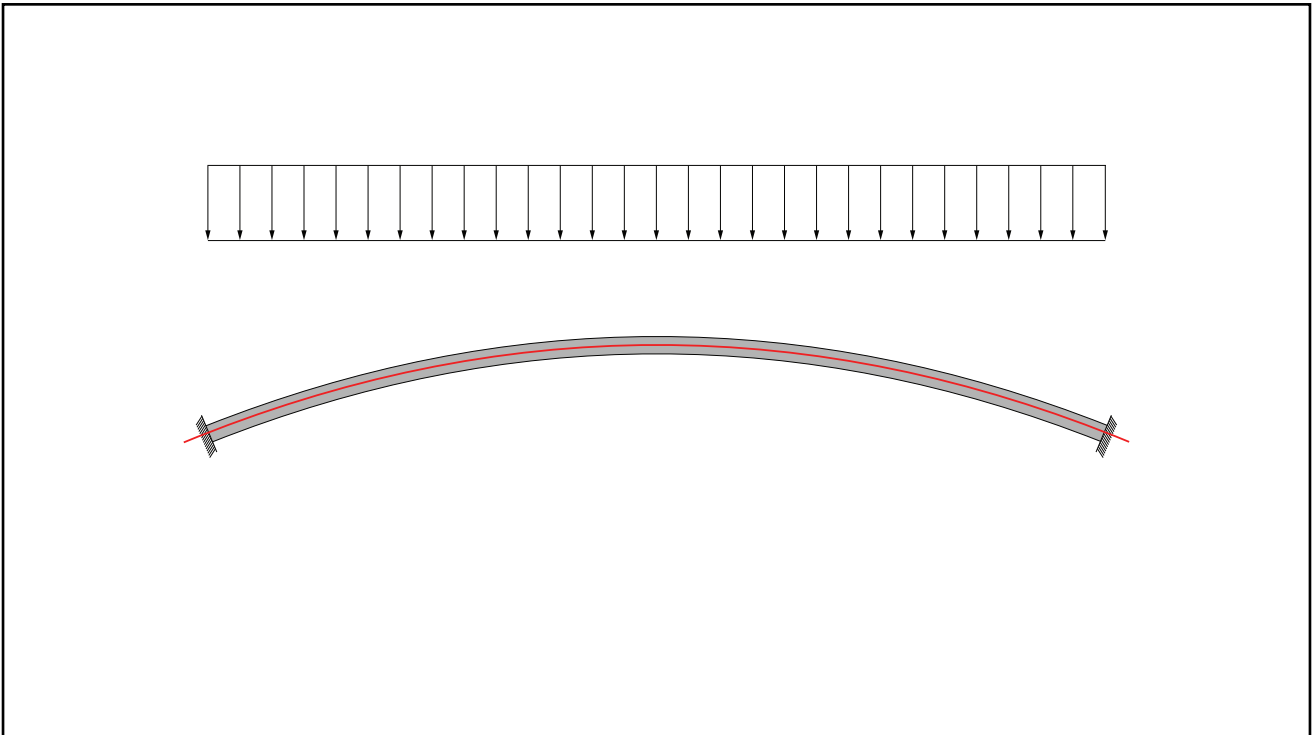

16

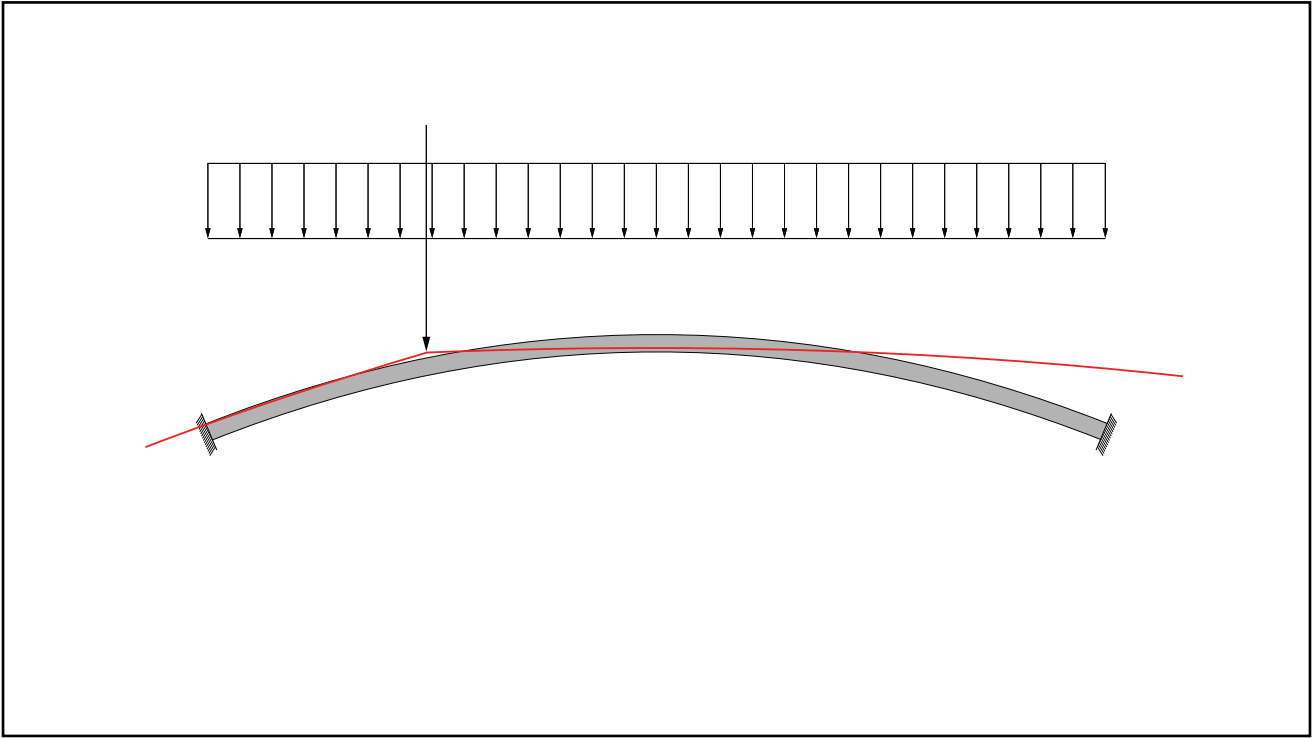

17

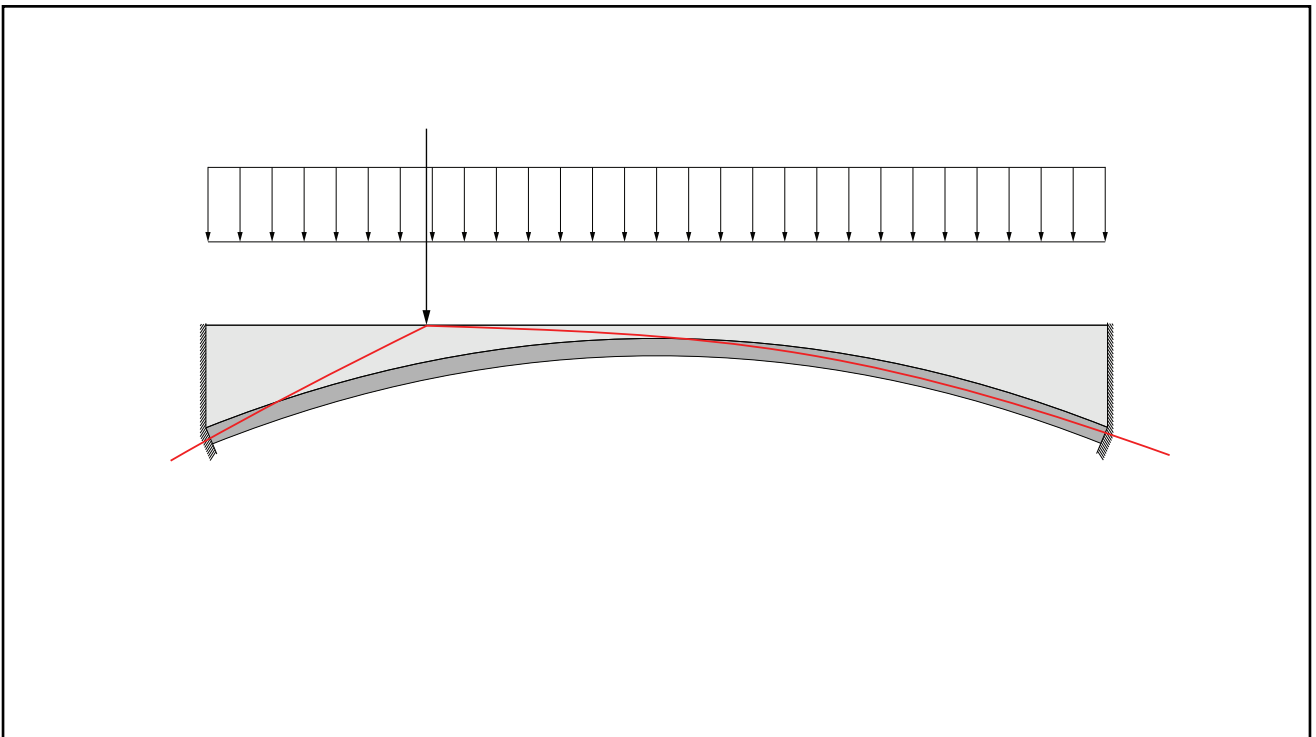

18

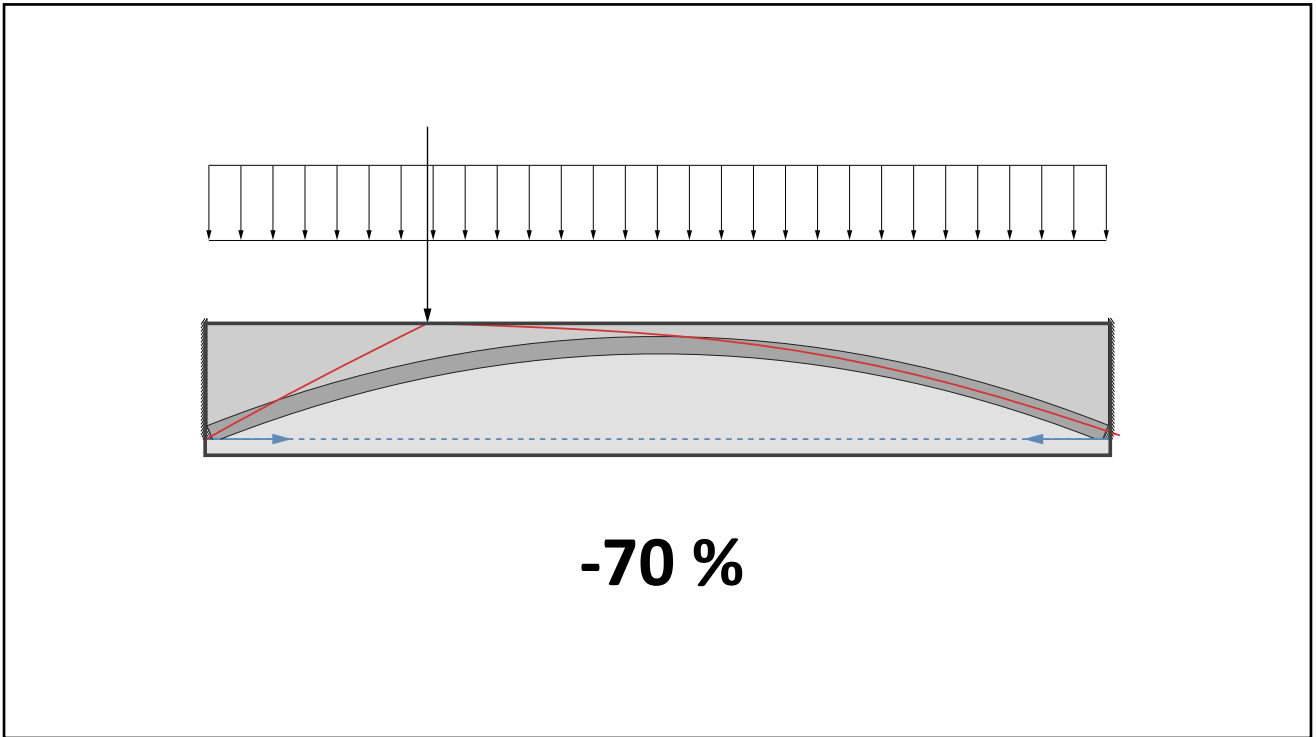

19



20



21

ETH meets NYC

New York City, NY, USA, 2015

22



© Pixar

23



© ReWall

24



25



26



27



28



29



30



© Phillip Ross

31



© Carlina Teteris

32

Armadillo

Venice, Italy, 2016

33



Photo: Iwan Baan

34



35



36

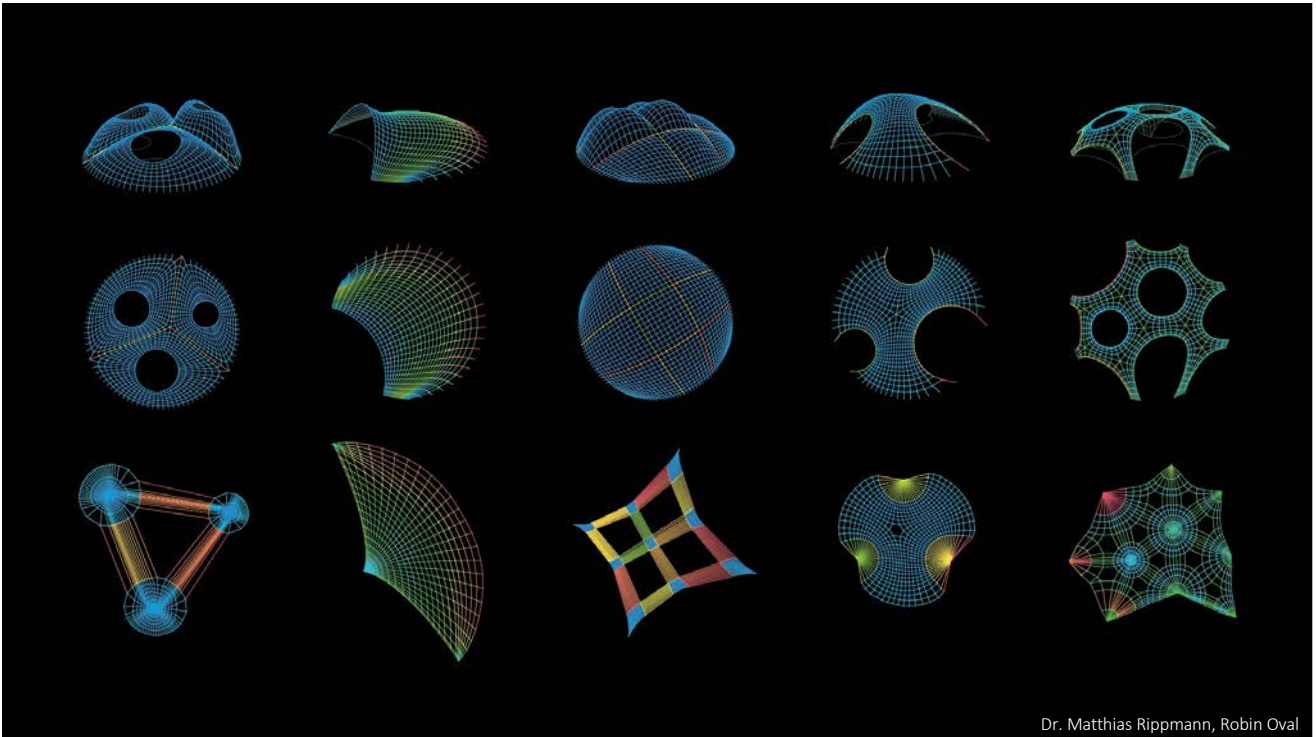

37

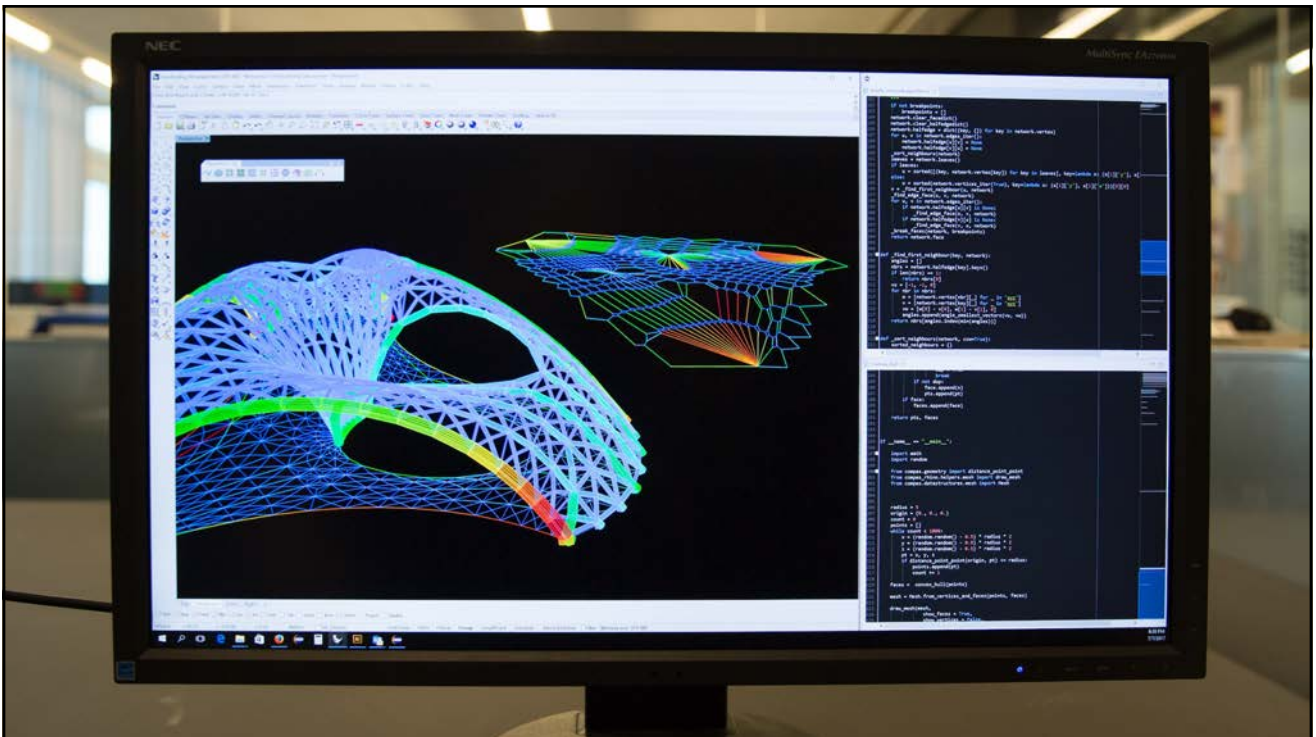

38



Photo: Skender Ijazovic

39



Photo: Anna Maragkoudaki

40



41



42

Striatus

Venice, Italy, 2021

43



44



45



46



47



48



49



50



51



52

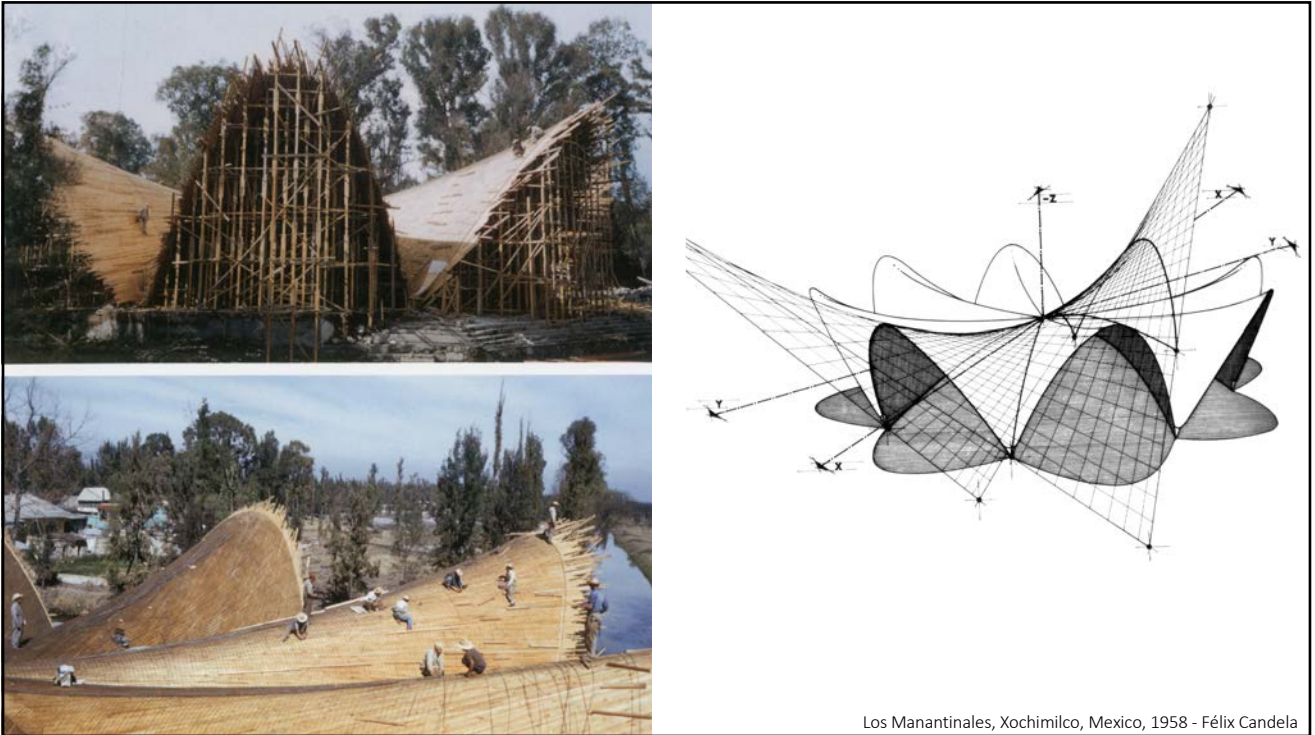

53



54



55



56

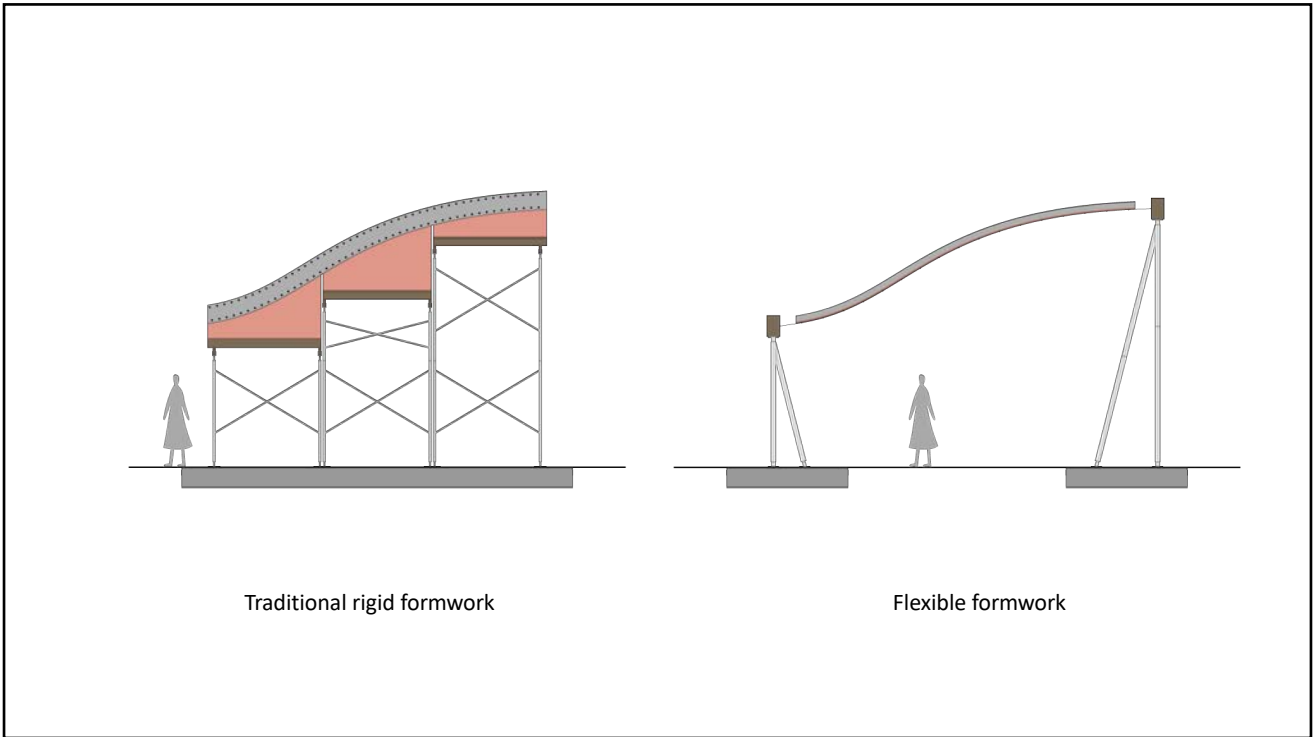

57

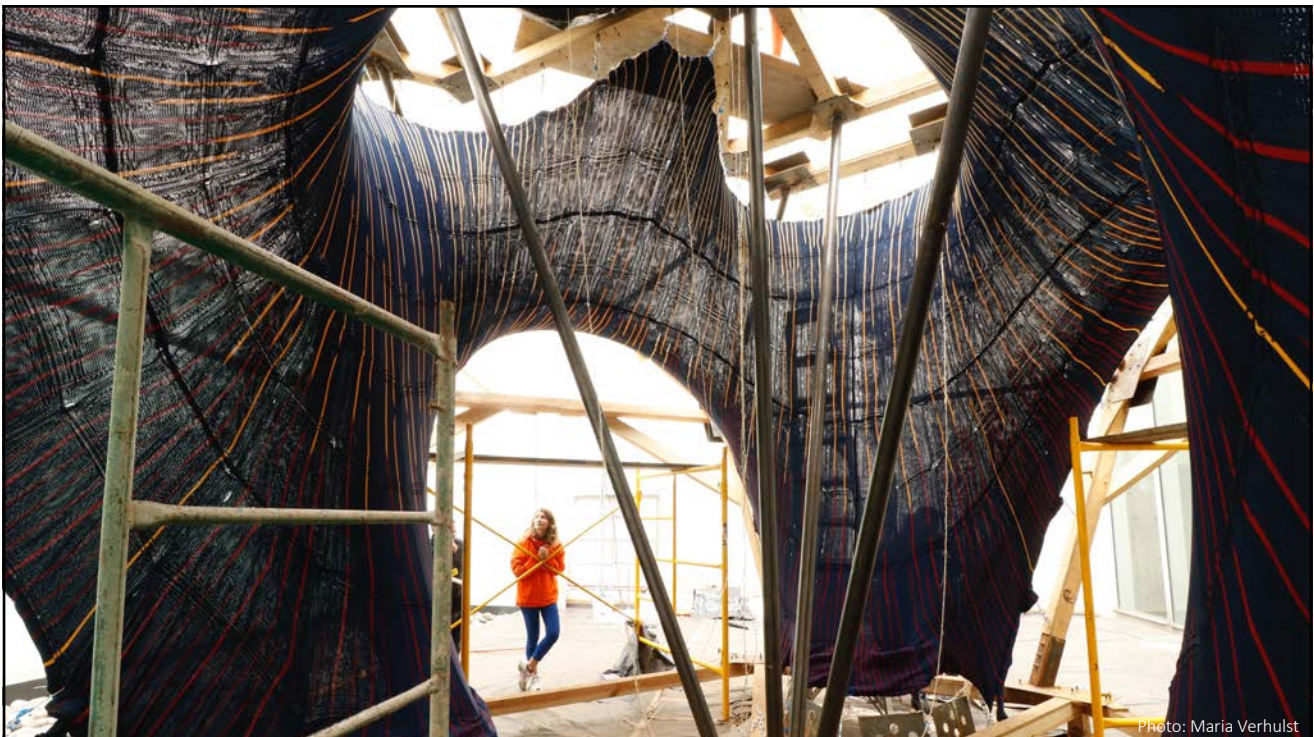

58



Photo: Mariana Popescu

59



Photo: Mariana Popescu

60

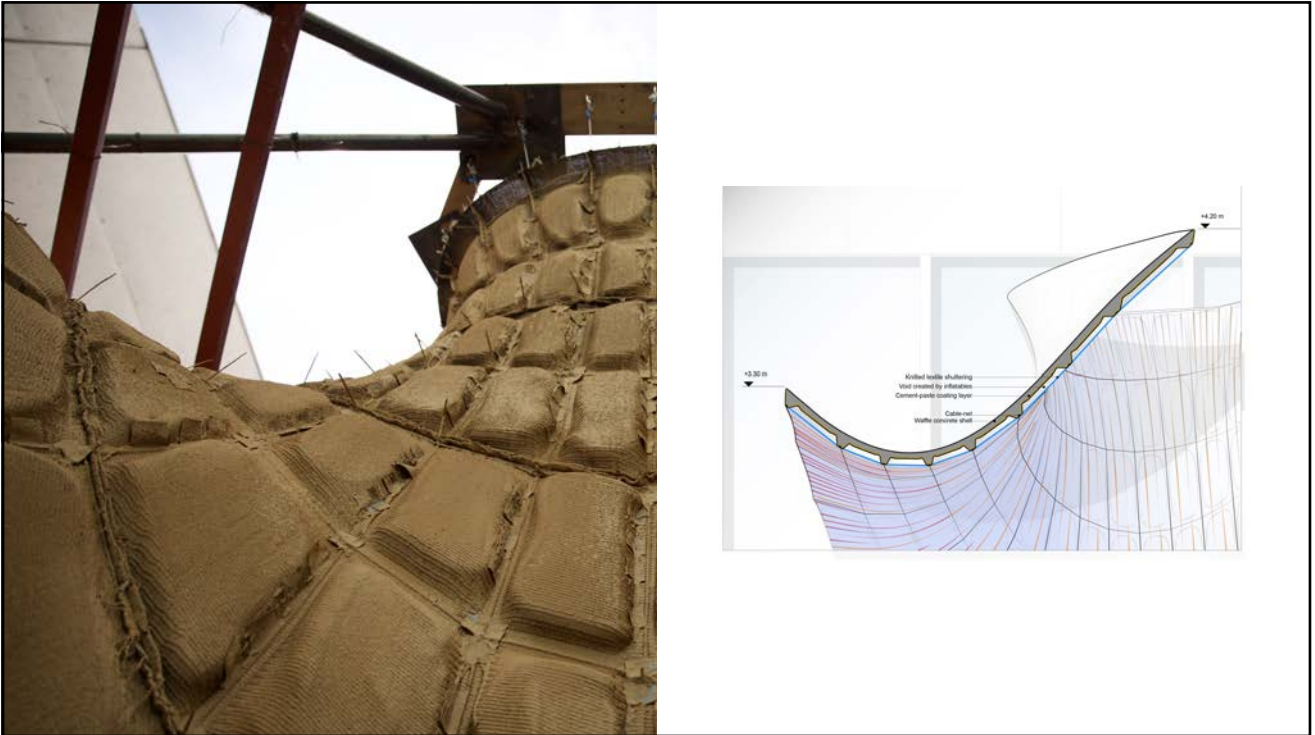

61



62



63



64

HiLo

Dübendorf, Switzerland, 2021

65



66

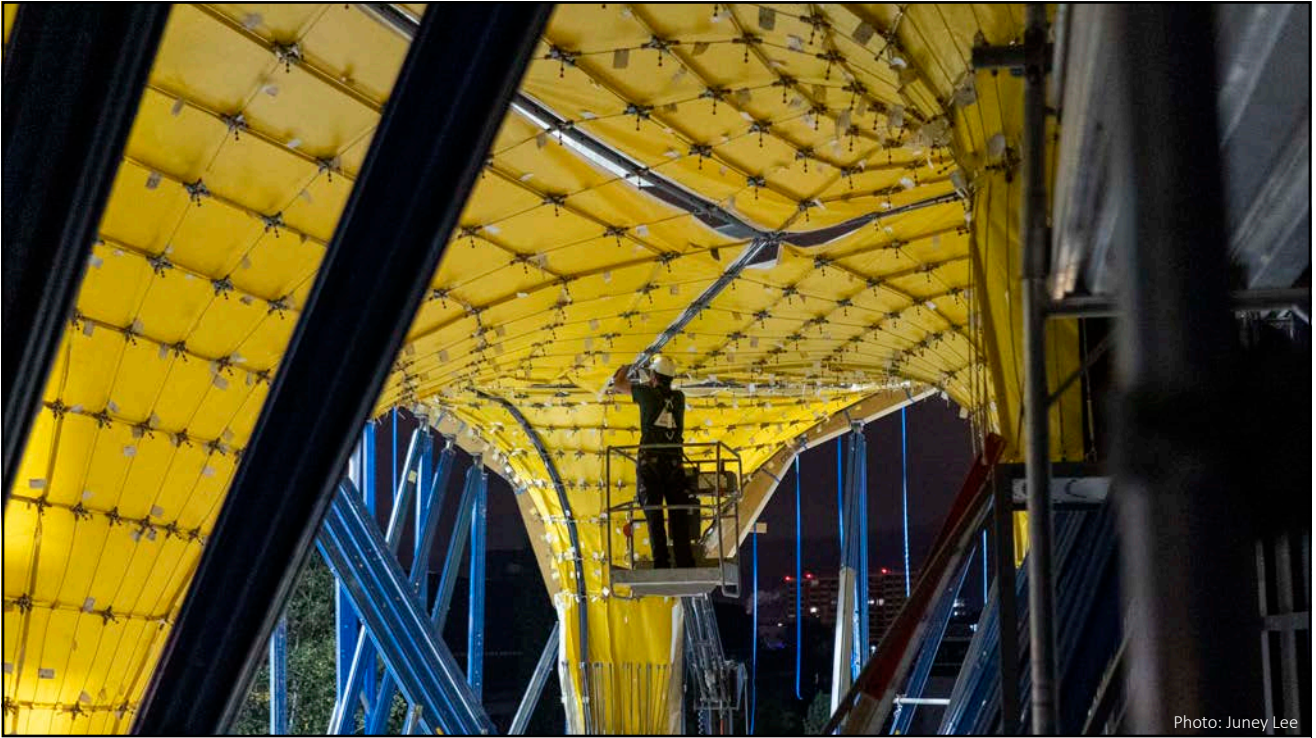

Photo: Juney Lee

67



Photo: Stefan Liniger

68

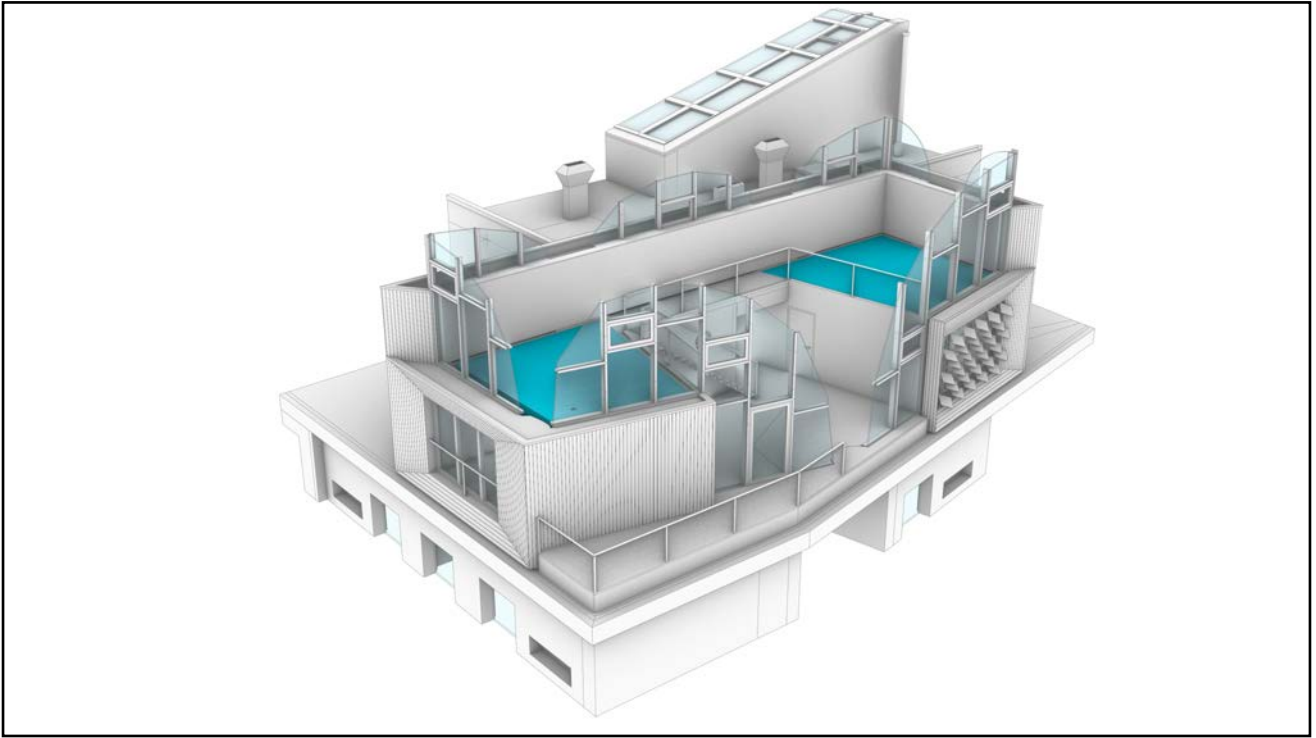

69



70

Impact

71

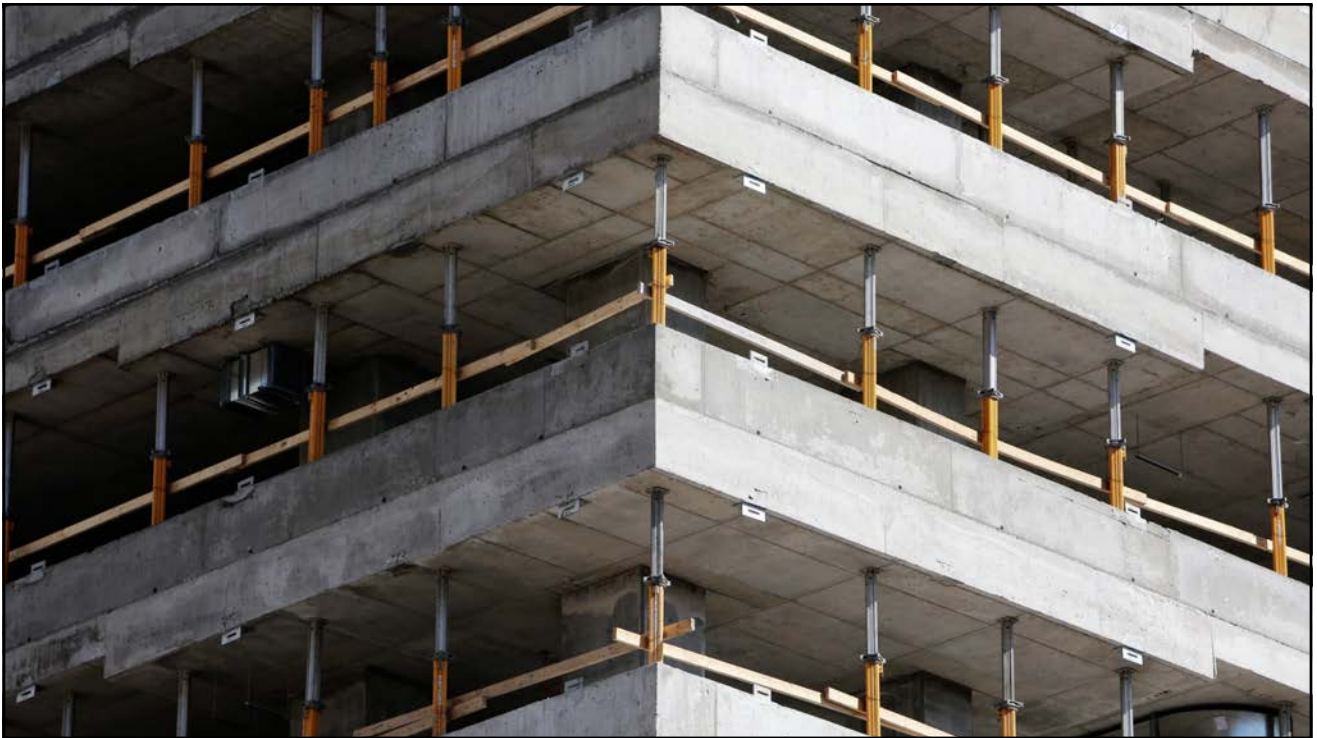

72

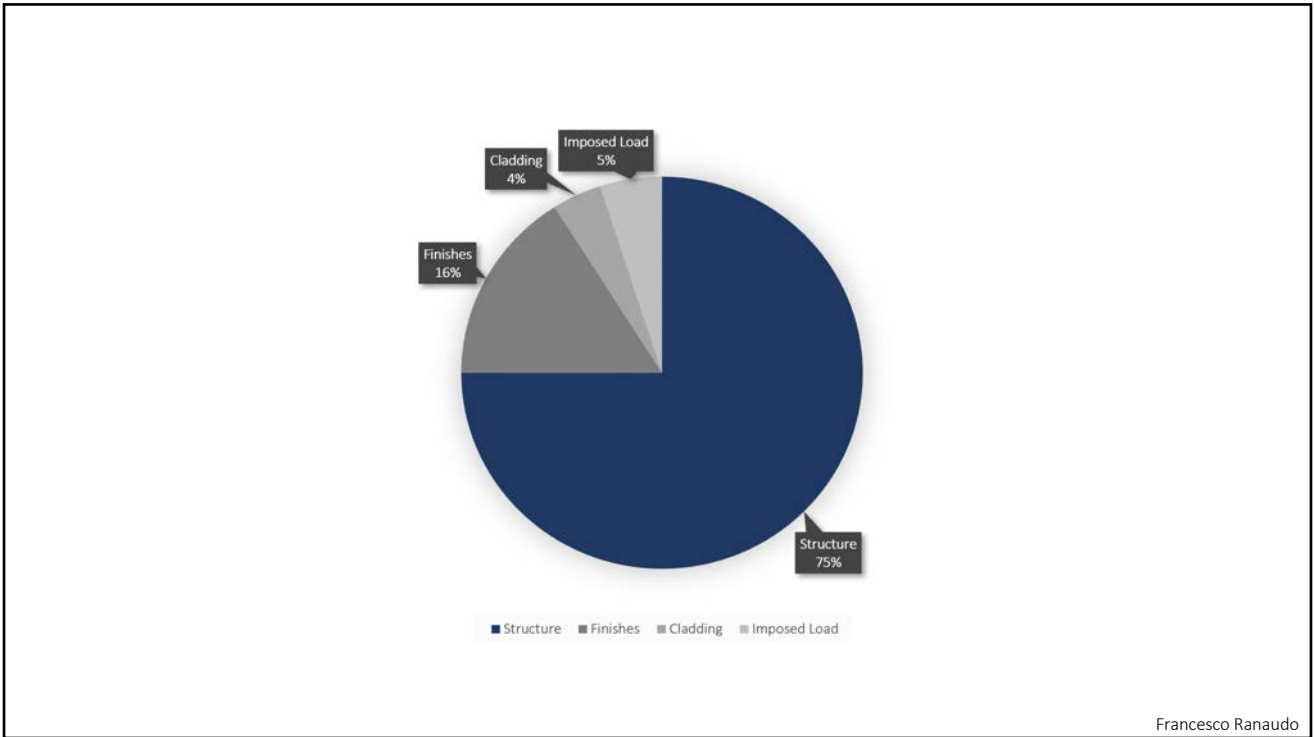

73

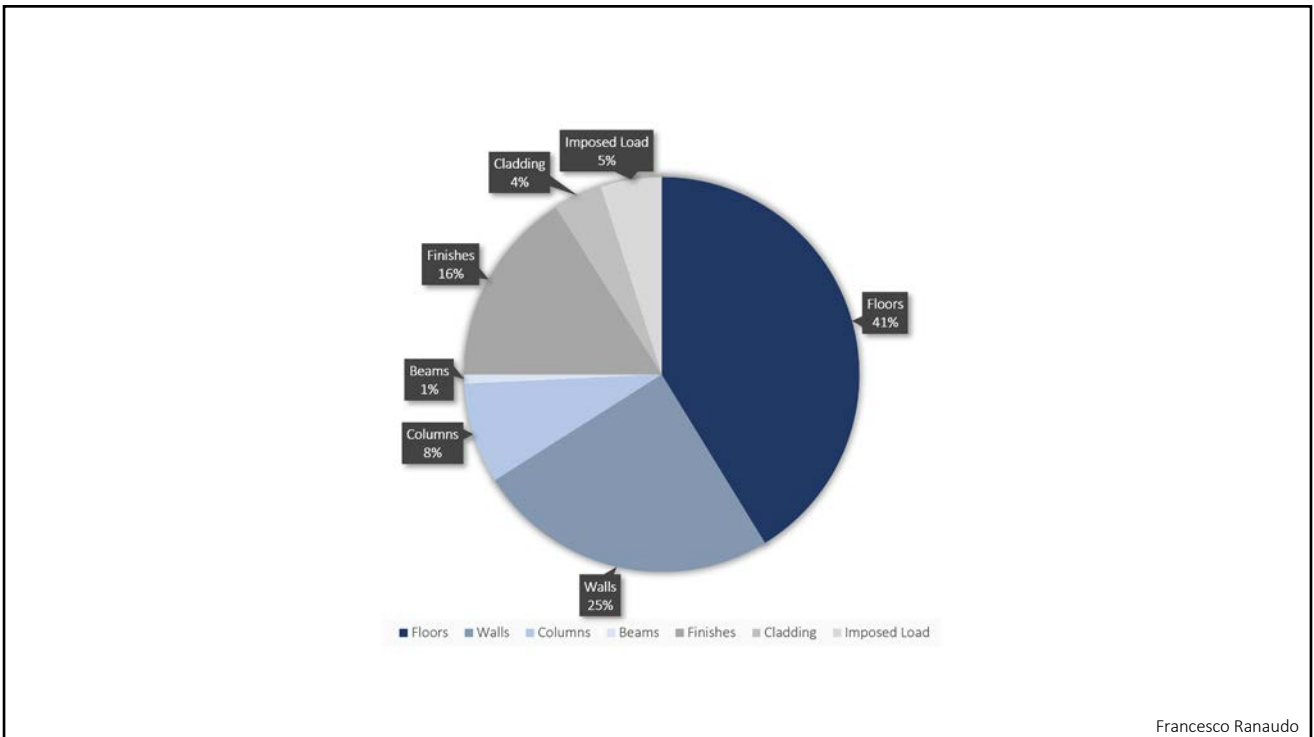

74



300 Bn m²

75

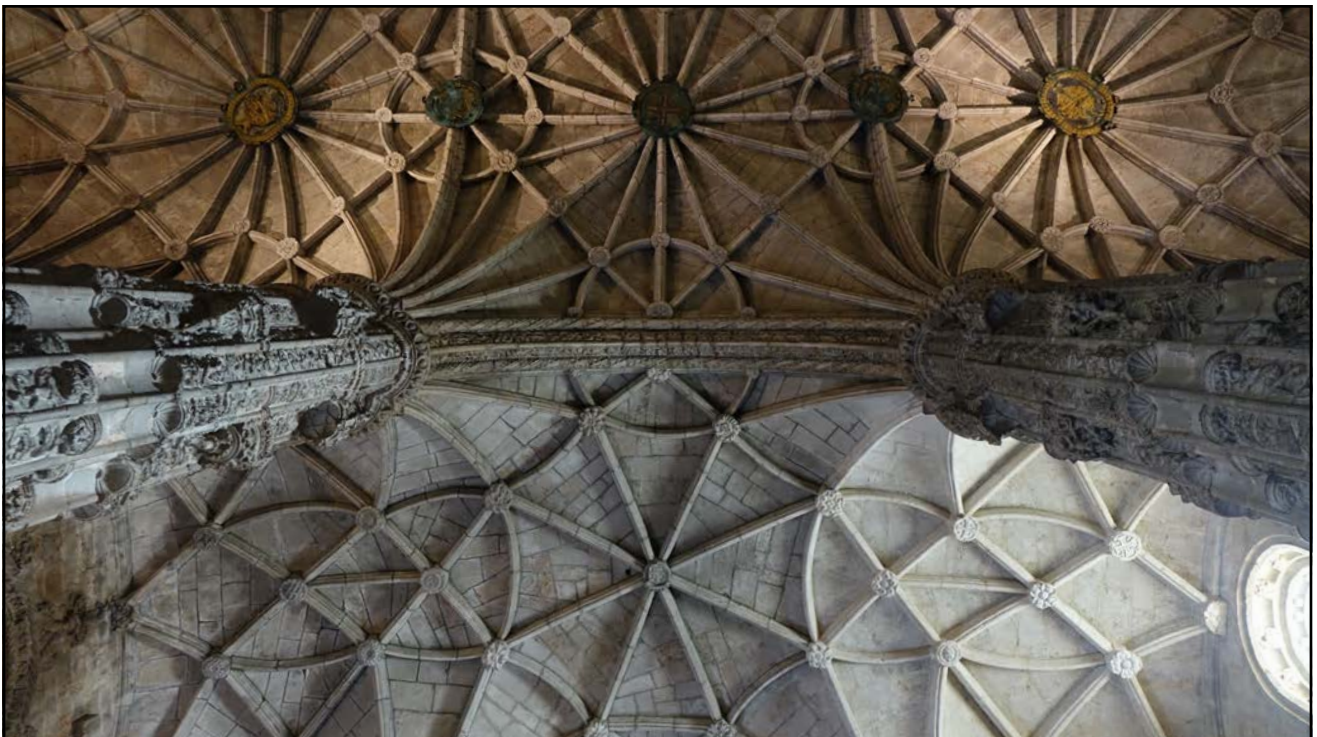

76

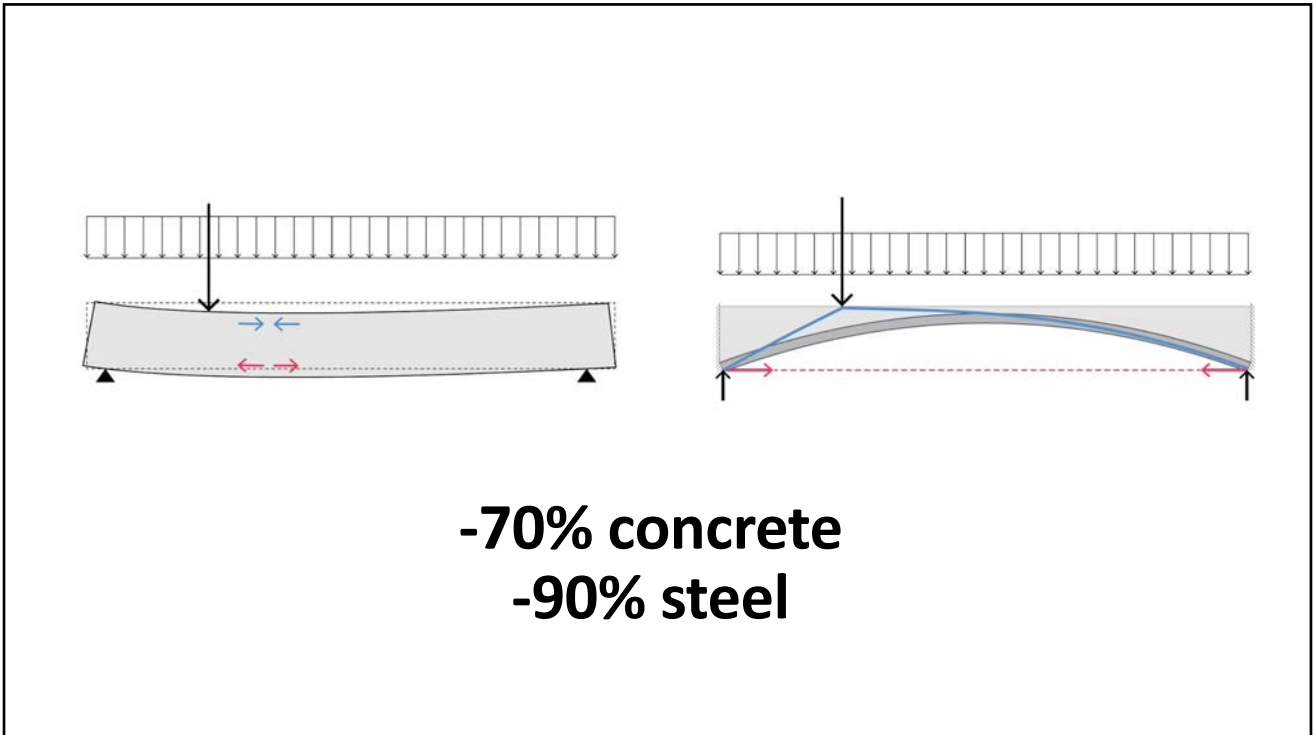

77

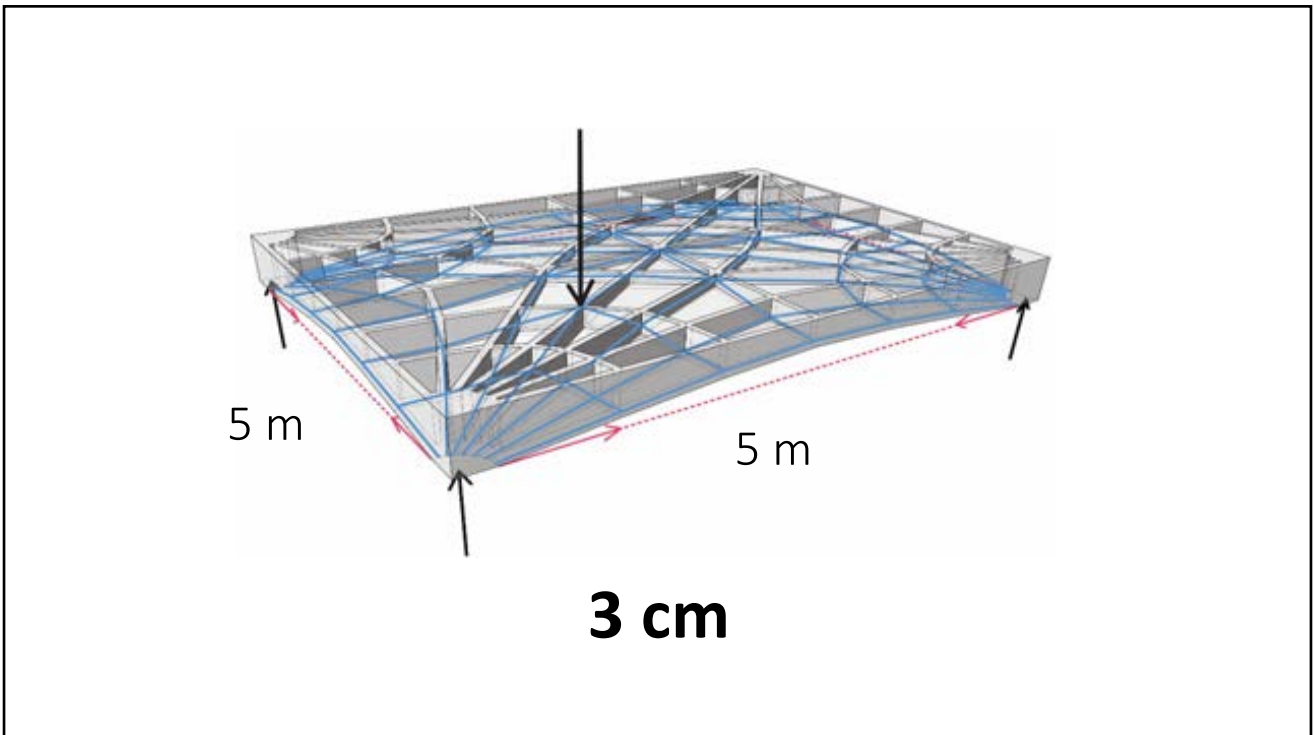

78



79

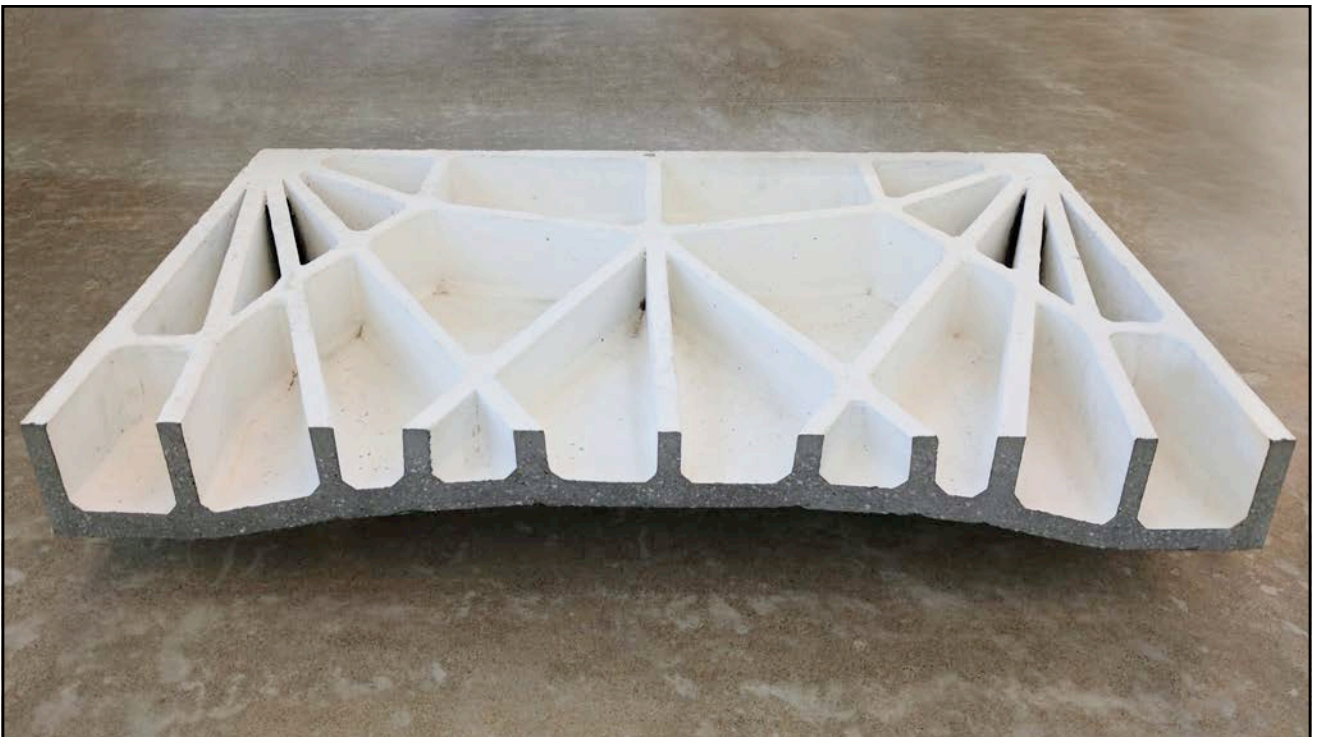

80



81

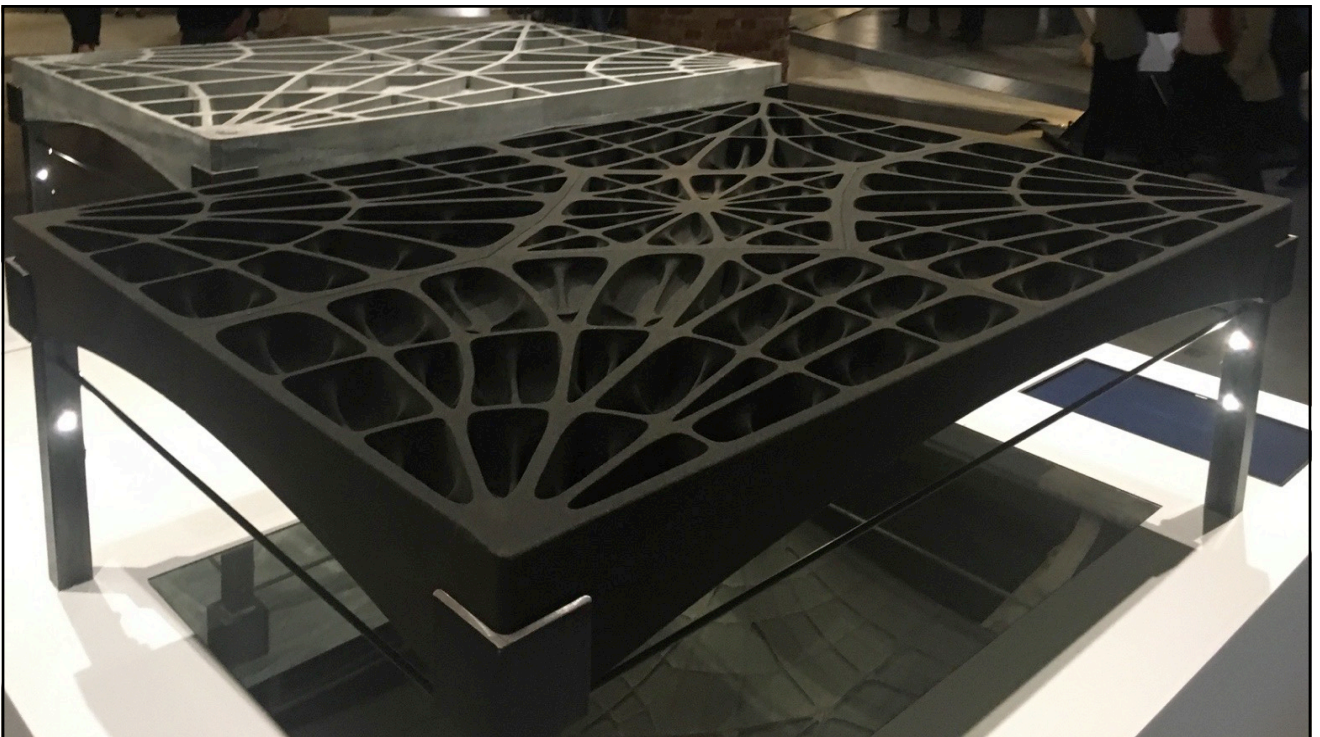

82

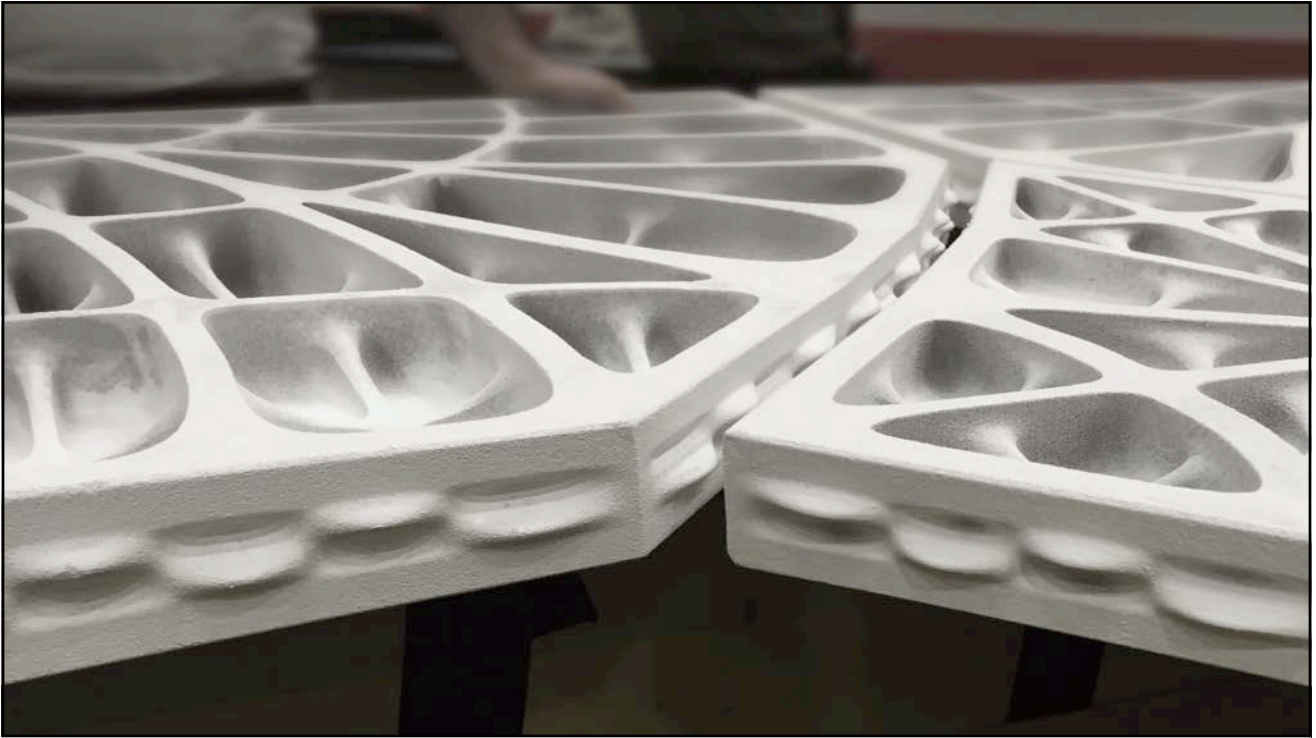

83

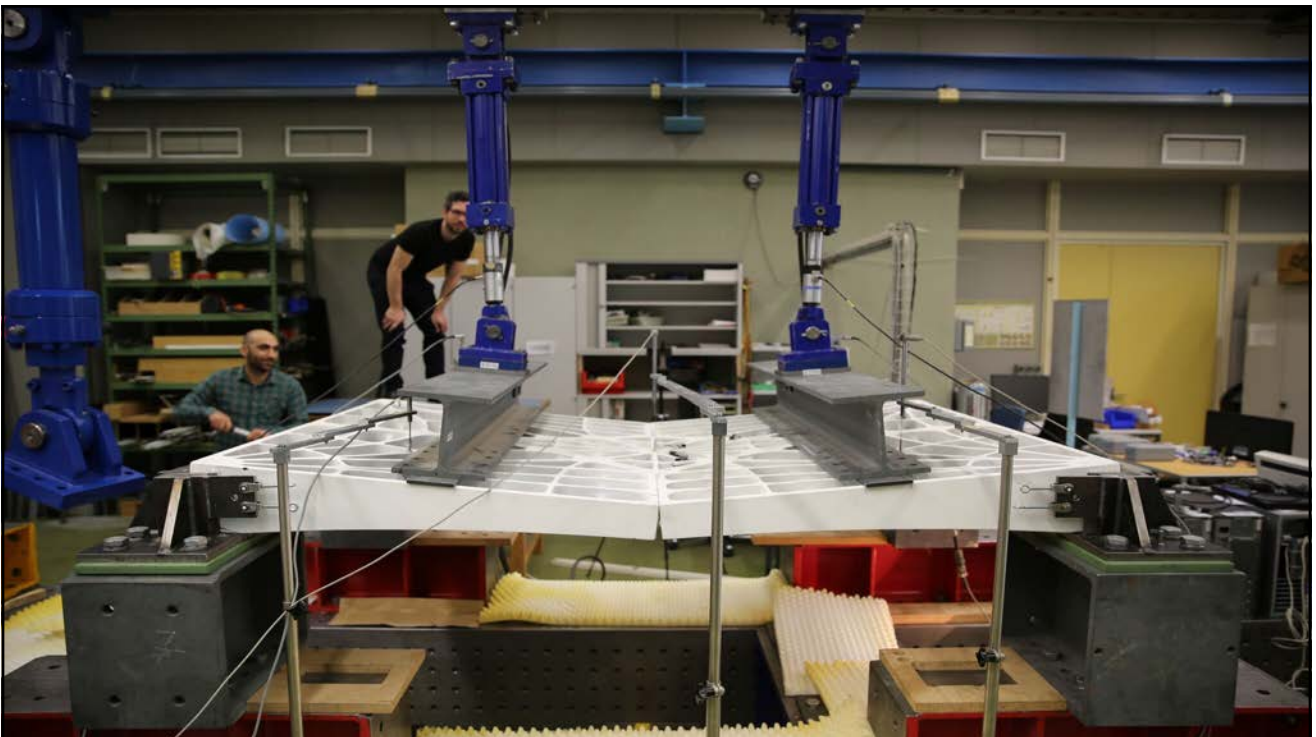

84



85

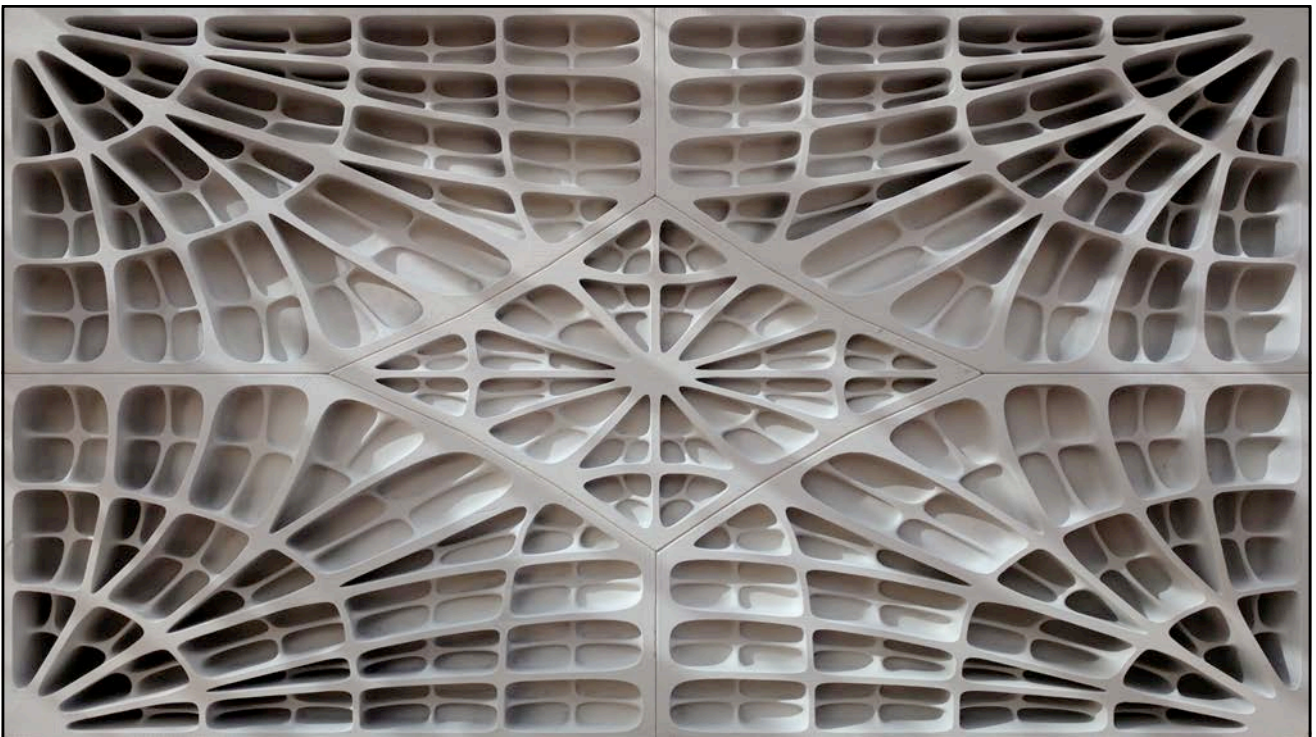

86



87

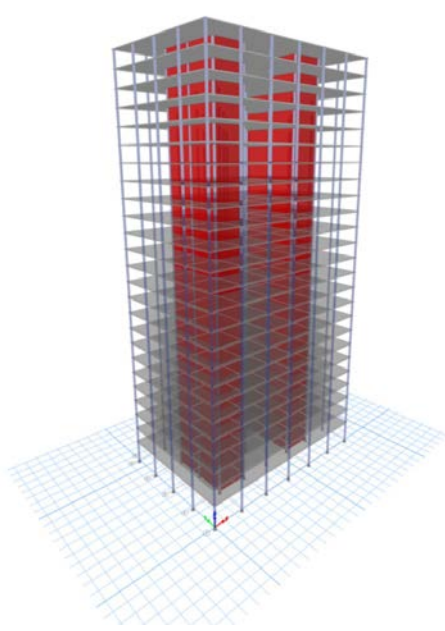

- Number of stories: 25
- Typical span: 7m
- Floor plate: 35m X 50m

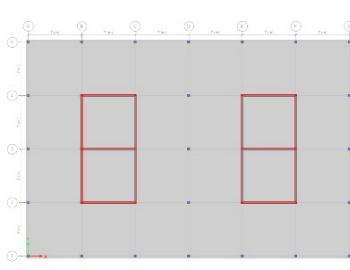

Francesco Ranaudo

88

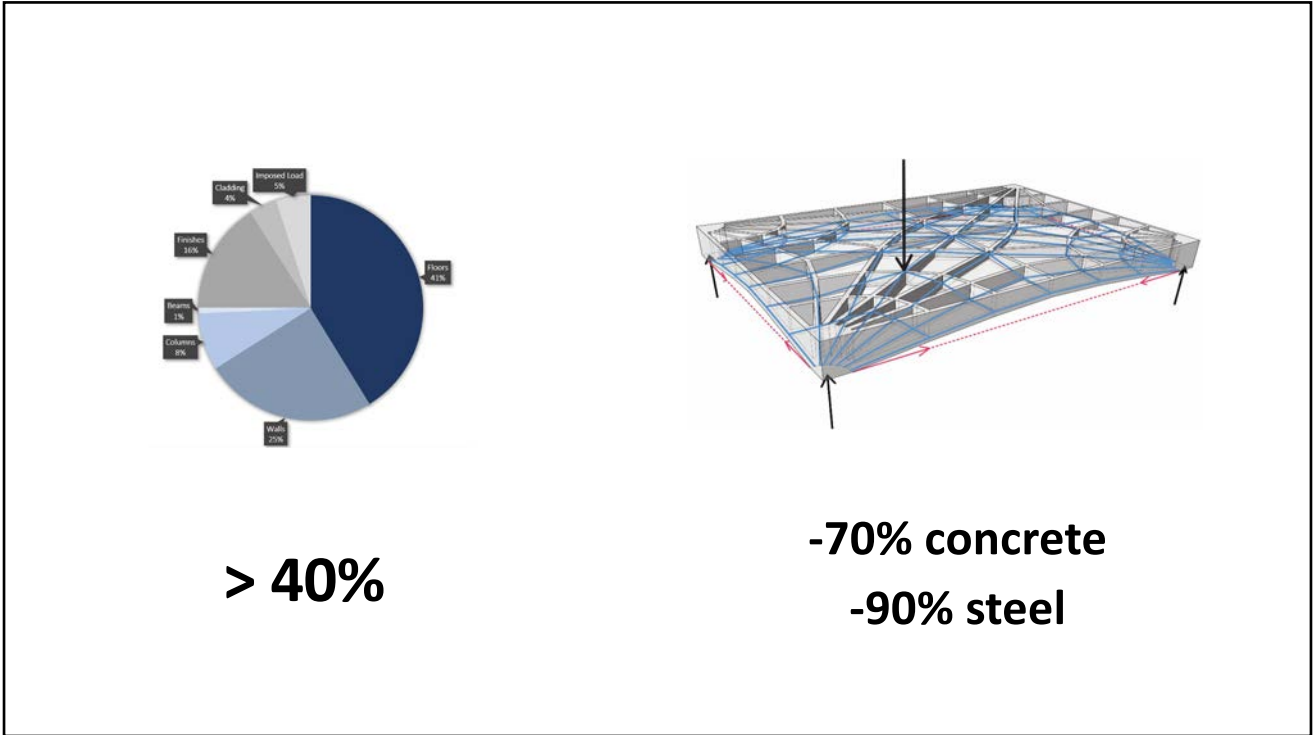

89



90

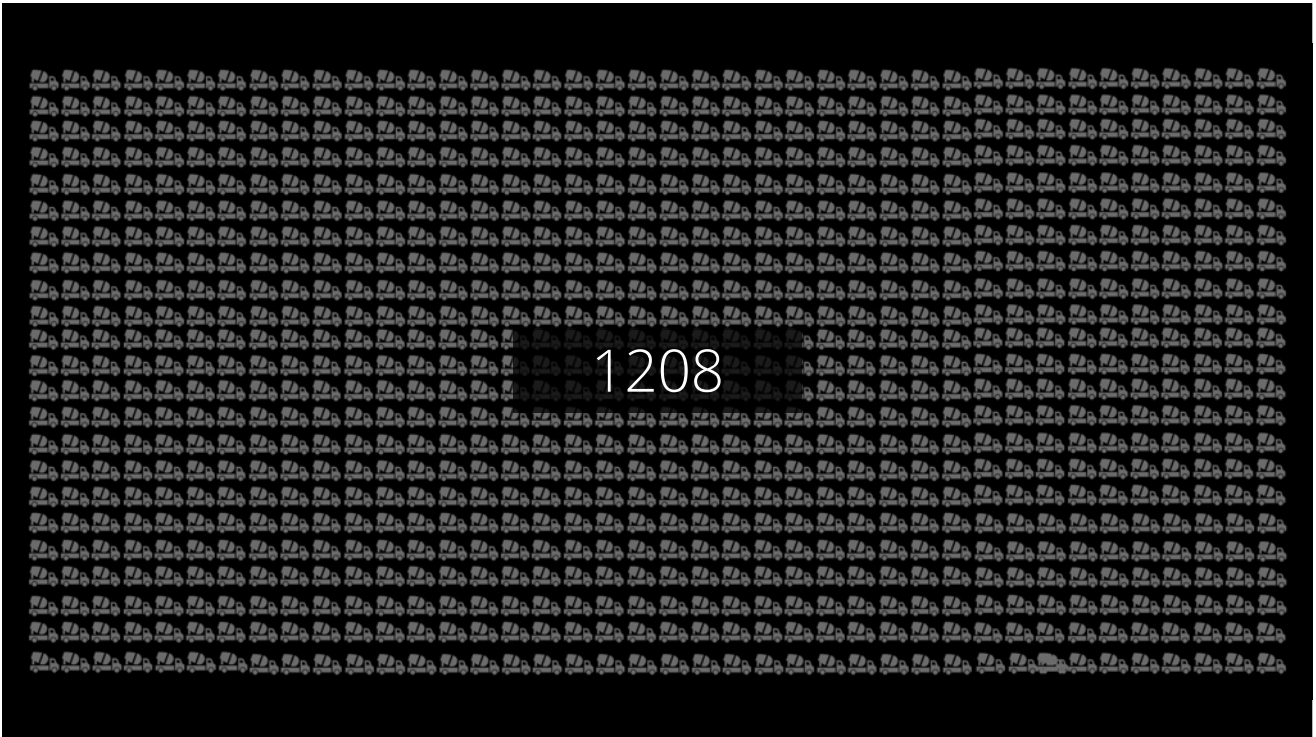

91

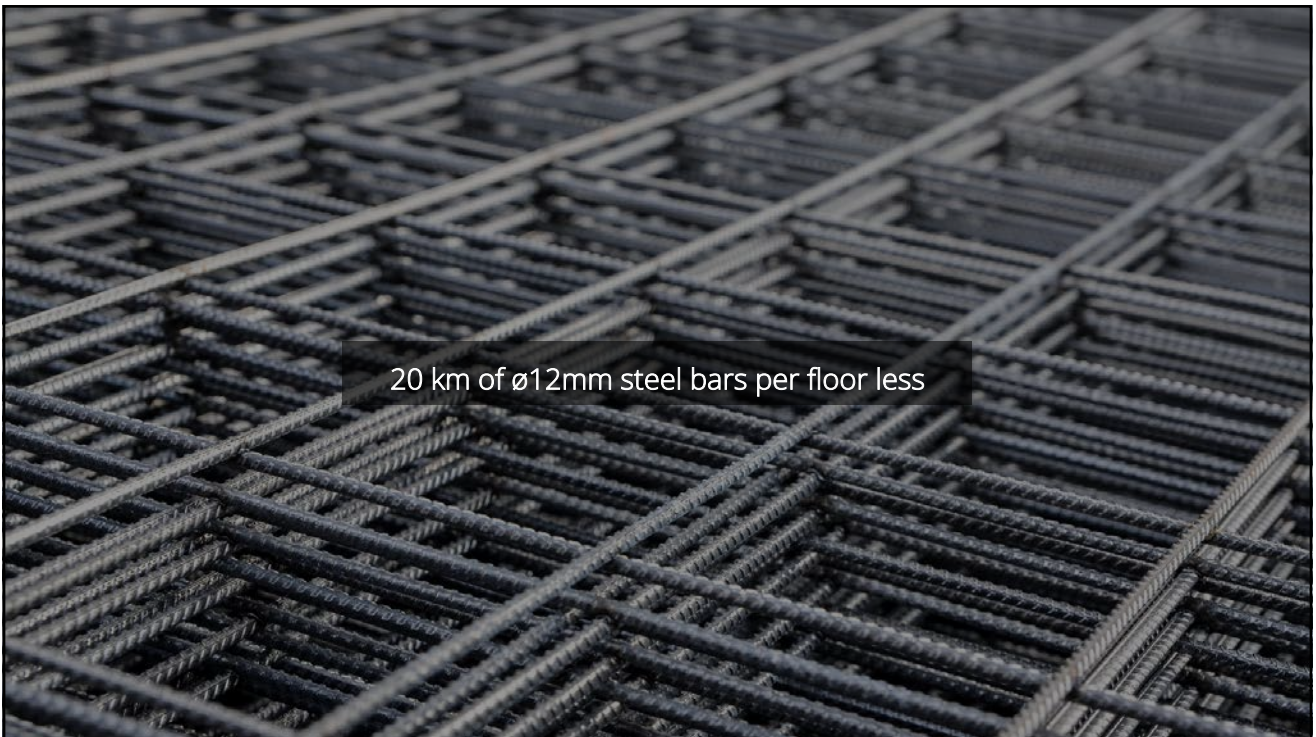

92

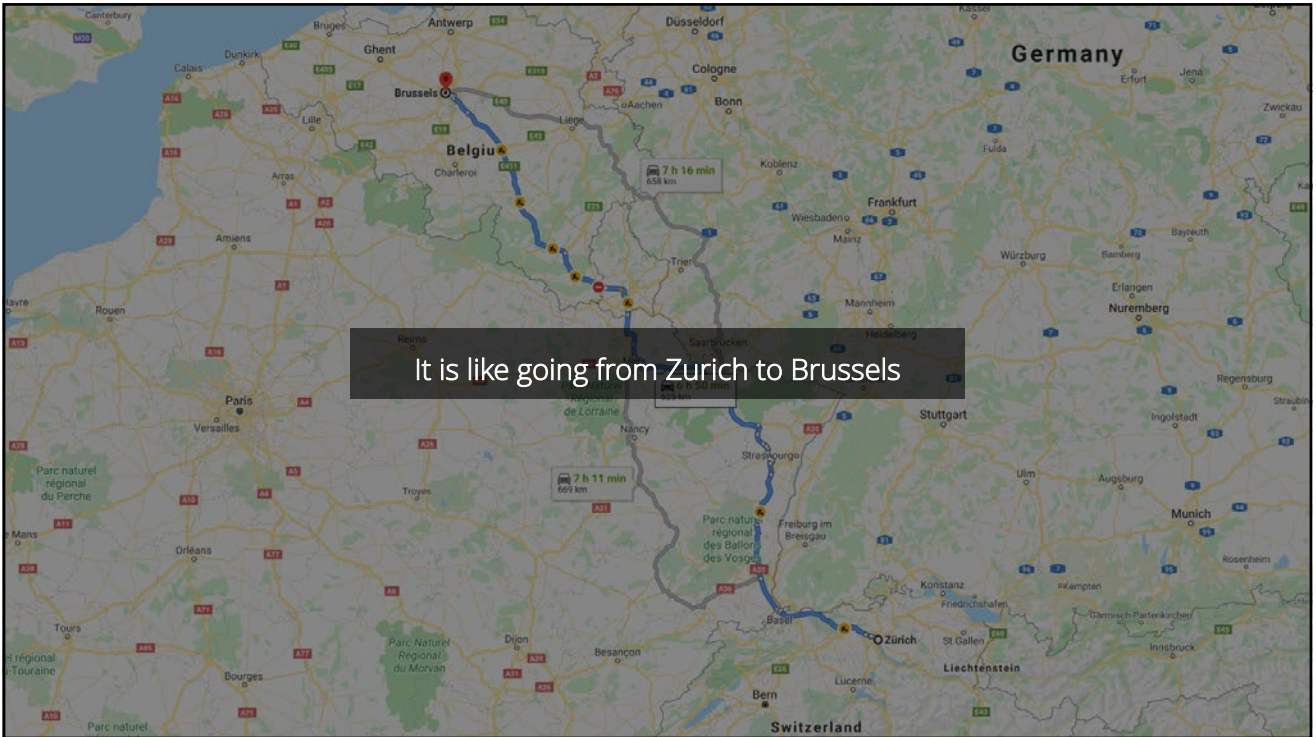

93



94



95

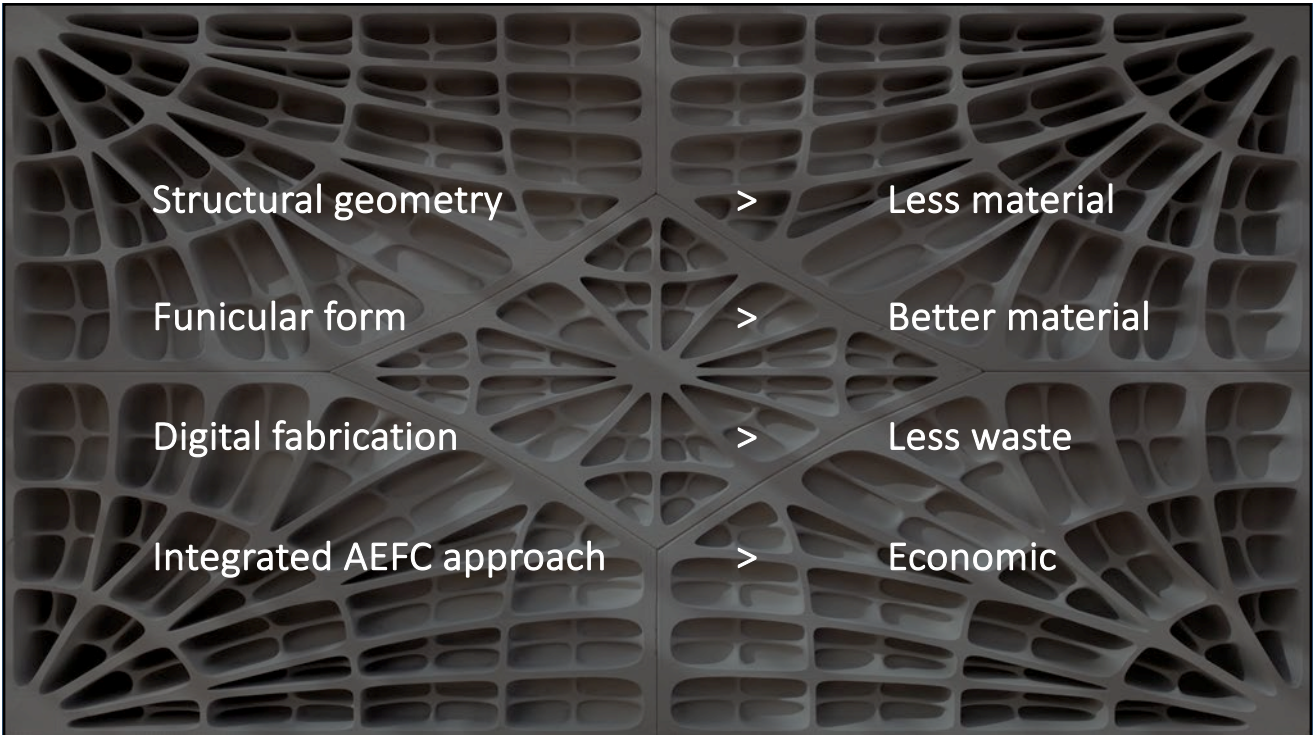

96



97



98